

RELEASE DATE Sep 07

# WARATAH SEED

Space Qualification Mission (WS-1)

## WS-1 Commercial Clients: Info Pack V2

Tuesday, 07 September 2021

### Contents:

Waratah Seed Satellite Control Document.

TRL Definitions

Contact Info

### STAGE 1 - TECHNICAL GUIDES:

The WS-1 Information Pack contains critical design and technical information, including the current version of the Satellite Interface Control Document and the Technology Readiness Level Definitions that will inform your STAGE 1 application.

Additional details, including an updated Info Pack, will be provided to successfully shortlisted applicants prior to their Second and Third Stage applications. Please ensure that you are using the Most Recent Version of these guidelines at each stage of your application.



# Waratah Seed Satellite Interface Control Document

PREPARED BY: XUELIANG BAI,  
YOUNGHO EUN  
REVIEWED BY: XIAOFENG WU

APPROVED BY: IVER CAIRNS

DATE: 02/09/2021  
POC: X.BAI@SYDNEY.EDU.AU



## Revisions

	Version No.	Author	Change Log
19/07/2021	V1.0	XL, YH	First release
6/08/2021	V1.1	XL	Small tweaks on wording and project schedule
17/08/2021	V1.2	XL	Change of project schedule
23/08/2021	V1.3	IC, XL	Small tweaks on wording and project schedule
02/08/2021	V1.4	XL, IC	Minor changes to the UART connection description



## Table of Contents

<b>1. Introduction and Scope .....</b>	<b>4</b>
<b>2. WS-1 Bus design.....</b>	<b>4</b>
<b>2.1. Bus design based on CUAVA-1 heritage .....</b>	<b>4</b>
<b>2.2. Bus capability Summary.....</b>	<b>5</b>
<b>2.3. Payload Computer Design.....</b>	<b>6</b>
2.3.1. Payload Computer Design Overview .....	6
2.3.2. Payload Computer Communication interfaces.....	6
<b>3. WS-1 Software Design.....</b>	<b>6</b>
<b>3.1. KubOS overview .....</b>	<b>6</b>
<b>3.2. Kubos Core Services.....</b>	<b>7</b>
<b>3.3. Mission Applications.....</b>	<b>7</b>
<b>3.4. Designing Payload API and Service.....</b>	<b>8</b>
<b>4. Payload Interfaces.....</b>	<b>8</b>
<b>4.1. Electrical Interface.....</b>	<b>8</b>
<b>4.2. Power budget .....</b>	<b>9</b>
<b>4.3. Power constraints.....</b>	<b>9</b>
<b>4.4. PC104 interfaces.....</b>	<b>9</b>
<b>4.5. Mechanical Design:.....</b>	<b>9</b>
4.5.1. Standard mechanical interface.....	9
4.5.2. Customized mechanical interface for larger payloads .....	11
<b>5. WS-1 Design Restrictions and suggestions.....</b>	<b>12</b>
<b>6. Qualification Testing/Flight Acceptance and Licencing .....</b>	<b>12</b>
<b>7. Project schedule .....</b>	<b>12</b>



## 1. Introduction and Scope

Waratah Seed is intended to be Australia’s 1st Ride-Share satellite and the first NSW-built satellite (specifically a 6U CubeSat) focused on space industry & commercial applications. Waratah Seed is a pilot space qualification project to launch NSW-developed space technology into orbit to test and prove functionality. The project is focused on developing Australia’s space sector, particularly NSW space industry.

The Waratah Seed project is led by the ARC Training Centre for CubeSats, Uncrewed Aerial Vehicles (UAV) and their Applications (CUAVA). CUAVA is funded by the Australian Research Council. Working with its academic, industry and government partners, its primary mission is to train the next generation of workers in advanced manufacturing, commercial space, and UAV applications. In doing so CUAVA will develop new instruments and technology to solve crucial problems, and develop a world-class Australian industry in CubeSats, UAVs, and related products. CUAVA has been in operation since December 2017, with headquarters at the University of Sydney. As well as CUAVA, the Waratah Seed partners are the Australian Centre for Space Engineering Research (ACSER) at University of New South Wales (UNSW), Saber Astronautics, Delta-V Space Hub, Macquarie University and the University of Technology Sydney (UTS).

The design of the Waratah Seed-1 (WS-1) Satellite bus is based on the 3U CUAVA-1 CubeSat bus, but with upgraded ADCS system and an additional high-speed communication system subject to requirements and contribution. This document is created to provide a concise overview of the various interfaces of WS-1 for payload developers. The satellite design is subject to changes due to payload requirements and budget constraints before the CDR stage without prior notice. It is recommended to reach out to the Waratah Seed engineering team after using this document to guide your initial payload design.

## 2. WS-1 Bus design

### 2.1. Bus design based on CUAVA-1 heritage

The satellite bus is mainly designed using commercial-off-the-shelf (COTS) products as listed in Table 1.

**Table 1: WS-1 bus components**

Subsystems/Functional components	Component Description	Source
On-board controller (OBC)	ISIS iOBC Onboard computer	<a href="https://www.isispace.nl/product/on-board-computer/">https://www.isispace.nl/product/on-board-computer/</a>
Full duplex UHF/VHF transceiver	ISIS.TrxVU full duplex radio	<a href="https://www.isispace.nl/product/cubesat-antenna-system-1u-3u/">https://www.isispace.nl/product/cubesat-antenna-system-1u-3u/</a>
Deployable VHF/ UHF antenna system	ISIS.deployable antenna system	<a href="https://www.isispace.nl/product/isis-uhf-downlink-vhf-uplink-full-duplex-transceiver/">https://www.isispace.nl/product/isis-uhf-downlink-vhf-uplink-full-duplex-transceiver/</a>
Electrical power system (EPS) and battery pack	GomSpace NanoPower P31us with 4 battery pack	<a href="https://gomspace.com/shop/subsystems/power/nanopower-p31u.aspx">https://gomspace.com/shop/subsystems/power/nanopower-p31u.aspx</a>
S-band communication system and antenna	ISIS High Data Rate S-Band Transmitter (TBD)	<a href="https://www.isispace.nl/product/isis-txs-s-band-transmitter/">https://www.isispace.nl/product/isis-txs-s-band-transmitter/</a>
Solar Panels	GomSpace Modular Solar Panels (MSP) for 6U structure	<a href="https://gomspace.com/shop/subsystems/power/msp-solar-panels.aspx">https://gomspace.com/shop/subsystems/power/msp-solar-panels.aspx</a>
Attitude Determination and Control system (ADCS)	CubeSpace CubeADCS 3-axis reaction wheels (1-3Deg pointing accuracy)	<a href="https://www.cubespace.co.za/products/integrated-adcs/3-axis/">https://www.cubespace.co.za/products/integrated-adcs/3-axis/</a>
Satellite Structure	ISIS 6U CubeSat Structure	<a href="https://www.isispace.nl/product/6-unit-cubesat-structure/">https://www.isispace.nl/product/6-unit-cubesat-structure/</a>
Payload OBC	In-house designed, can be customized subject to payload providers’ requirement	Based on the Pocket Beagle opensource design: <a href="https://beagleboard.org/pocket">https://beagleboard.org/pocket</a>
Flight Preparation Panel and debug interface panel	In-house designed, can be customized subject to payload providers’ requirement	

In addition to the above bus components, a high-speed communication system will be selected to increase the downlink bandwidth. The high-speed radio system is to be selected. If a payload has large data needs then these need to be communicated to the Waratah Seed team; meeting these needs may require additional financial contributions to be made by the payload team.

Optionally, we can add a star tracker to increase the pointing accuracy to 0.5-0.1 degree (subject to payload provider’s requirements and contributions).

A system diagram, with assumed payloads, is shown in Figure 1.

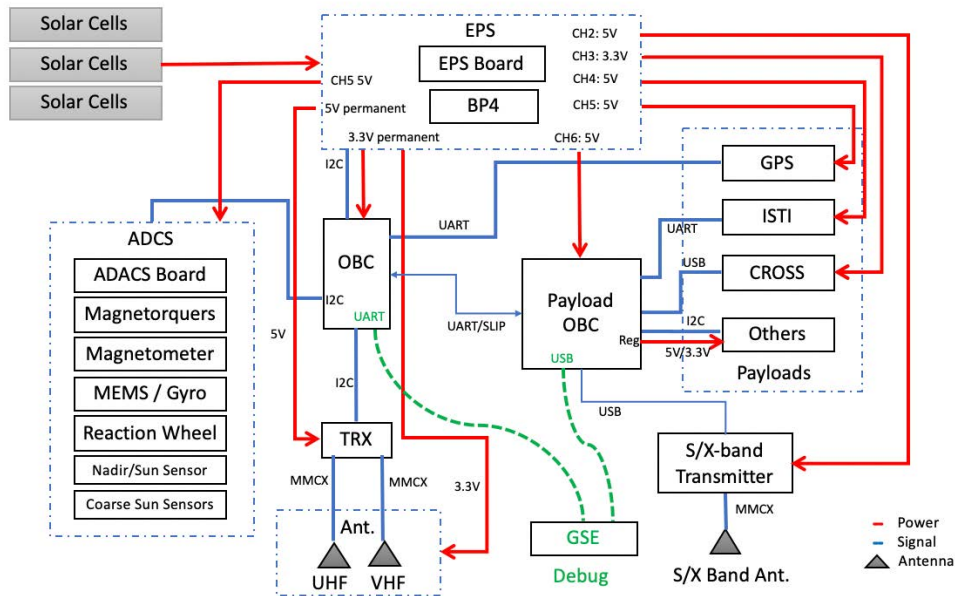

Figure 1: WS-1 system diagram

Note that most of the payloads shall be connected to the payload OBC rather than the satellite OBC unless specified otherwise. Both the satellite OBC and the payload OBC will be running a customized Linux (KubOS, as discussed in section 3). It is possible to have a second payload OBC if the number of the payloads is more than the payload OBC ports. The satellite OBC and the payload OBC(s) are connected via the Serial Line Internet Protocol (SLIP) interface as point-to-point ethernet connection(s). Each telecommand uplinked to the satellite radio(s) will be enveloped by a “space packet” (<https://public.ccsds.org/Pubs/133x0b2e1.pdf>), where the command ID, IP address, port number etc. are specified. When received by the satellite radio, the radio service will distribute the command to the correct payload service. For more details about the radio service, please refer to SW-1 Preliminary Design Review.

## 2.2. Bus capability Summary

CPU: 400MHz, 32-bit ARM9 CPU

RAM: 32MB SDRAM

SD-Card: 2 x 2GB

UHF/VHF datarate: 9600bps

S-band (TBD): 4Mbps

Pointing accuracy: 1-3 Degree

Solar panel power: ~20W

EPS and battery: 6 configurable outputs (5V or 3.3V) with battery maximum depth of discharge 7.5Whr

Bus volume (without payload computer): approximately 1.5U as shown in Figure 3.

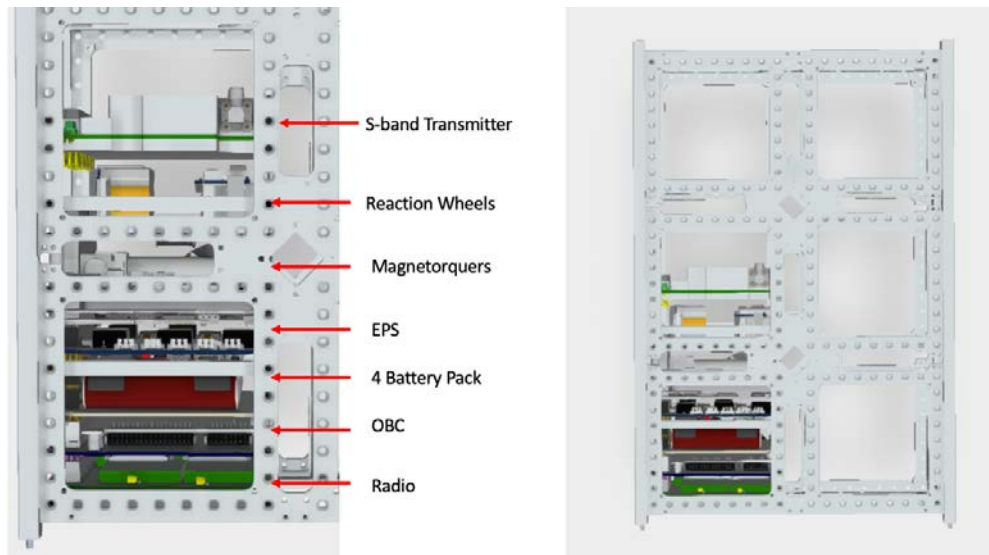

**Figure 2: Waratah Seed Bus Design**

## 2.3. Payload Computer Design

### 2.3.1. Payload Computer Design Overview

The payload computer design is still in progress. The design will be based on the Pocket Beagle design (<https://github.com/beagleboard/pocketbeagle>).

The payload computer will be connected to a 5V@2A power channel. It will include a power selection chip to select and deliver 5V@1A to up-to 12 payloads. It is recommended to use a Beaglebone Black or Pocket Beagle board to test the software interface during payload development. Depending on the number of payloads, it may be possible to add a second payload computer on the WS-1.

Before payload delivery, the Waratah Seed or CUAVA team will provide a payload computer to the payload team to test the software interface.

### 2.3.2. Payload Computer Communication interfaces

- UART (3 sets): 4pin picoblade connector. up to 500kbps (115.2kbps if using Serial Line Internet Protocol (SLIP)) LSB first, no parity, 8 data bits, 1 stop bit
- I2c (up to 6 devices): 4pin picoblade connector. 400kbps
- USB hosts (4 sets via a USB hub controller): Considering **TF38-22S-0.5SV (pin allocation TBD)**
- USB slave: Reserved for debug
- Ethernet port (1 set): Considering FPC or nano Dsub (**pin allocation TBD**).

## 3. WS-1 Software Design.

### 3.1. KubOS overview

The flight software is developed in-house by the CUAVA software team at the University of Sydney based on an open source embedded Linux named KubOS (Kubos, n.d.). KubOS is a package framework that runs directly on satellite hardware combining a customized Linux distribution, subsystem APIs, and core services. It provides some of the core functions for satellite developers such as File Transfer Protocol, mission scheduler etc.

Due to power constraints imposed by the ISIS OBC, we are designing a payload computer as discussed in Section 2. The payload computer(s) will also use the KubOS platform and will connect to the OBC via a point-to-point ethernet connection. The CUAVA team will provide the CROSS compiler for either of the computers and it is **NOT**

necessary to design your software API and service again in the case that we want to relocate your payload from payload computer to the OBC.

The OBC software architecture is shown below.

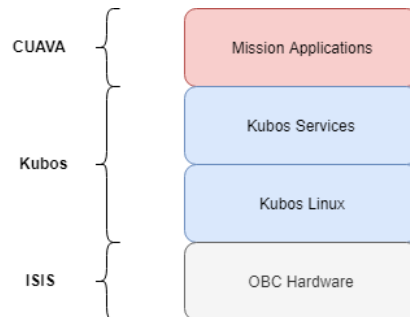

**Figure 3 - Architecture Overview**

- **Mission Applications:** Governs the behaviour of the satellite
- **Kubos Services:** Core and hardware services for interacting with the satellite, including services for mission specific bus components and payloads
- **Kubos Linux:** Custom Linux distribution designed for embedded devices
- **OBC Hardware:** ISIS on-board computer and in-house design payload computer

## 3.2. Kubos Core Services

Core services provide critical flight software capability but do not interact with hardware. The payload Concept of Operation (CONOP) will be based some of all of the below core services. They are developed by Kubos and currently include:

- Shell service (design by CUAVA)
- Telemetry database service
- File transfer service
- Process monitoring service
- Application service/registry
- Monitor service

## 3.3. Mission Applications

Handle all the onboard decision making and form the backbone of the satellite’s operation. The payload service will be based some of all of the below mission applications. The applications can include but are not limited to:

- Bootup and initialisation
- Time management
- Command processing
- Telemetry processing
- Data storage
- Fault protection
- Payload operation, logging and monitoring

There are also some mission specific Applications heritage from the CUAVA-1 mission that can be used for payload CONOP design:

- Radio inhibit and antenna deployment application
- ADCS commissioning and detumbling application
- ADCS pointing application



### 3.4. Designing Payload API and Service

Each payload on the satellite will require its own software for operation that will interface with the mission application software. When the payload is delivered, it shall come with functional payload Application interface (API) and service for testing (we can NOT consider the payload as “delivered” without a working service), it is possible to deliver your payload Application(s) after the payload hardware is delivered and before the environmental testing.

In addition to the documentation provided by KubOS, the CUAVA team also has tips and guides in our group wiki and code template to assist your payload service software design. The Waratah Seed and CUAVA teams will also provide workshops to get your team started and support during your development process.

**The services discussed above, together with the ground station terminal software forms the Mission Architecture as shown below:**

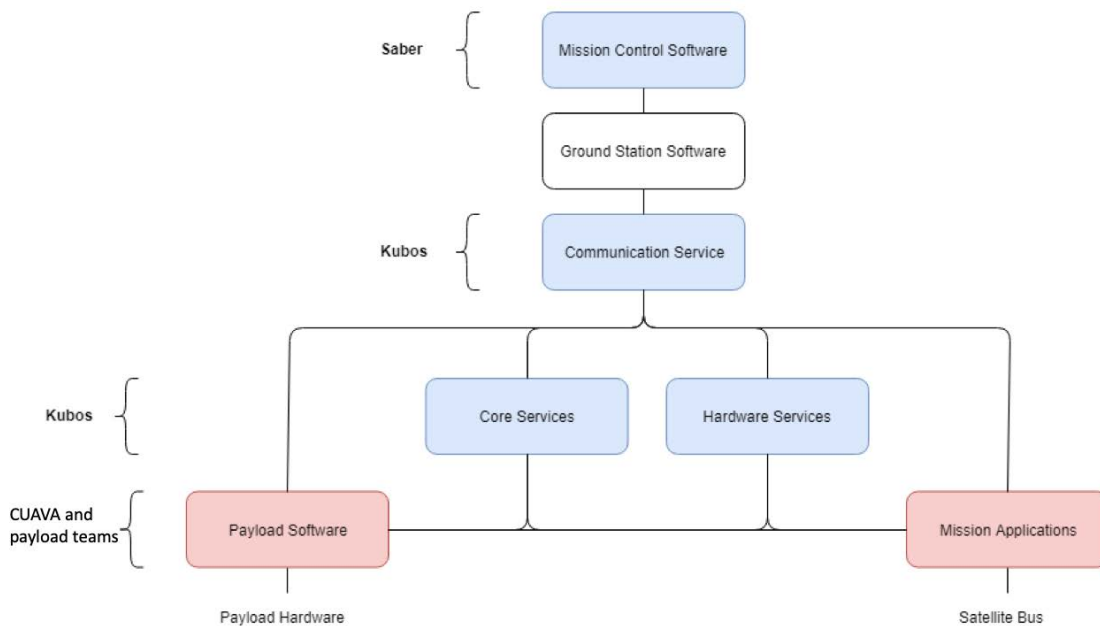

**Figure 4 - Mission Architecture**

## 4. Payload Interfaces

### 4.1. Electrical Interface

As mentioned in Section 2, **ALL** payloads shall be connected to the payload computer unless the Waratah Seed team specifies otherwise. The power will be delivered in the same connector with the communication bus from the payload computer. You can choose from UART, i2c interfaces (slave devices only), USB Host or Ethernet:

- UART (4 sets): 4pin picoblade connector. up to 500kbps (115.2kbps if using Serial Line Internet Protocol (SLIP)) LSB first, no parity, 8 data bits, 1 stop bit I2c (up to 6 devices)

Pin	Connection	Wire colour
1	GND	Blk
2	5V/3.3V	Red
3	RxD	Yellow
4	TxD	Orange



- i2c (Slave only): 4pin picoblade connector. Up to 400kbp, **pull up resistor already exist on the payload computer.**

Pin	Connection	Wire color
1	GND	Blk
2	5V/3.3V	Red
3	SDA	Green
4	SCL	Brown

- USB and ethernet connectors: please consult the Waratah Seed team for availability and pin allocations.

The allocation of the electrical interface allocation (especially for UARTs) will follow a first in first served principle and be subject to coordination between payload teams.

**4-pin picoblade connector is recommended and should be easily accessible for integration/reintegration.** For UART and i2C, and we generally encourage pin 1 to pin 1 connection. Please specify in your ICD if designed differently. Note that other connector types may introduce higher cabling cost.

#### 4.2. Power budget

For a nominal ~500km SSO orbit, WS-1 payloads will have approximately 5.0 watt-hours (Whr) available per orbit. This may be improved depending on utilisation of ADCS and mission pointing requirements.

#### 4.3. Power constraints

All payloads with size 0.5U or smaller shall restraint the power consumption below 5W@5V1A. For larger payloads with higher power consumption (up to 10W@5V2A), it is recommended to directly connect the payload to the PC104 stack and obtain power from EPS directly. There is a limited number of such 5V2A power channels and please consult the Waratah Seed team for availability.

#### 4.4. PC104 interfaces

This section is intended for i2c payloads that connect directly to the PC104 stack. The ground pins are H2-30, H2-29 and H2-32. The power channels are from H1-48 to H1-51. Due to design constraints, the number of the power channels directly from the PC104 stack will be extremely limited. Please discuss with the Waratah Seed team prior to your final PCB board design.

Note that Vbat (H2-45/46, ~8V), permanent 3.3V (H2-27/28) and permanent 5V (H2-25/25) are **NOT** available to the payload teams.

	20	22 DRXD	24	26 5V	28 3.3V	30 GND	32 GND	34	36	38	40	42	44	46 VBAT	48	50 GPIO 24	52 GPIO 28
H2	19	21 DTXD	23	25 5V	27 3.3V	29 GND	31	33	35	37	39	41	43	45 VBAT	47	49	51 GPIO 26
	20	22	24	26	28	30	32	34	36	38	40	42	44	46 GPIO 23	48 3.3V OUT1	50 3.3V OUT2	52 3.3V OUT3
H1	19	21 I2C SCL	23 I2C SDA	25	27	29	31	33	35	37	39	41 I2C SDA	43 I2C SCL	45 GPIO 22	47 5V OUT1	49 5V OUT2	51 5V OUT3

#### 4.5. Mechanical Design:

##### 4.5.1. Standard mechanical interface

The WS-1 satellite follows the CubeSat mechanical interface. Each stack has 4 ribs connected by 4 threaded rods. The pictures below illustrate the integration process and a complete 1U stack.

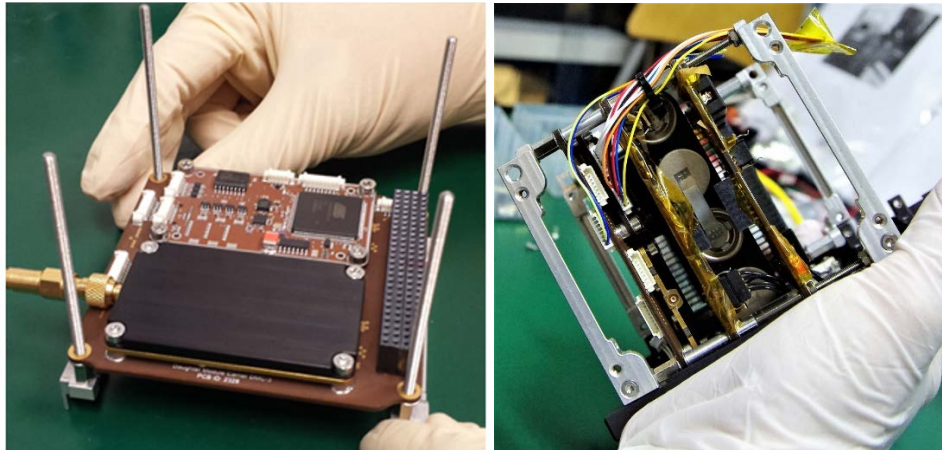
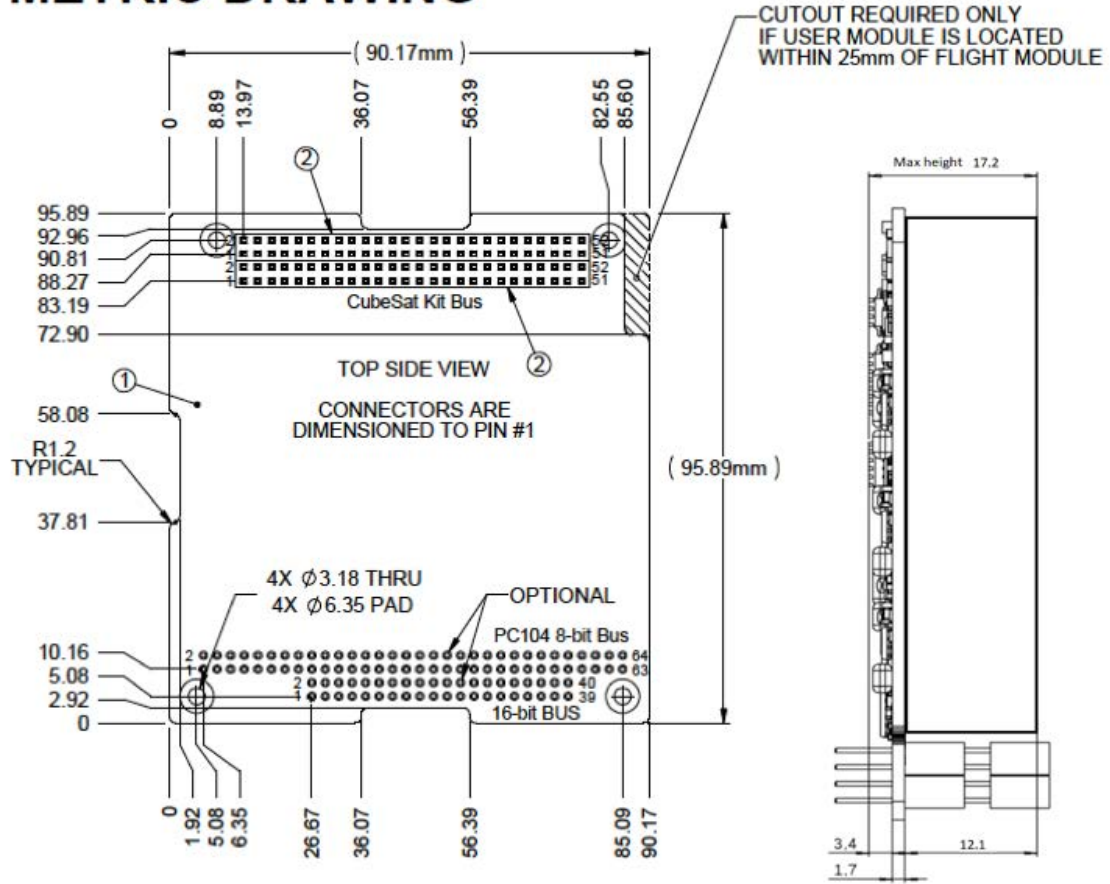

**Figure 5 – Mechanical interface for PCB boards**

For a standard 0.25U payload slot, the design should comply with the mechanical design as shown in Figure 6. Dimensions are given in mm. If your payload is selected, the Waratah Seed team will provide satellite CAD to guide your design. The mechanical interface (Metrics, mm) for the CubeSat standard PCB is shown in figure 6 (referenced the Pumpkin satellite CubeSat Kit PCB Specification). The imperial version of the drawing is attached in Annex 1.

Note that even if you are not using the PC104 stack for electrical interfaces, it is **recommended** to have it in place to increase the mechanical integrity of the stack. It is possible to have an alternative mechanical mounting design if the Waratah Seed team agrees following detailed discussions.

# METRIC DRAWING



ITEM	QTY	PART NUMBER	DESCRIPTION	MANUFACTURER
1	1	PC104 Spec PCB	User	User
2	2	ESQ-126-39-G-D	2x26 Stack-Through	Samtec.com

**NOTES:**

- 1) Connectors shown are .10" x .10" spacing, .025" square pin.
- 2) Samtec part numbers listed are low insertion force versions.
- 3) In the case where a 25mm gap will exist above the User Slot an additional connector should be used to gap the extra 10mm distance, plugged into the main connector. Use part SSQ-1XX-22-G-D where "XX" is the # of contacts per row.
- 4) These comments apply to situations where the User Module (Slot 1) is directly above the FlightModule (Slot 0).

**Figure 6 – WS-1 payload mechanical interface (measurements shown in mm) \***

\* For a 0.5U, 0.75U, 1U payload slot, the maximum height is 36.4mm, 55.6mm and 74mm respectively (Pin header height shall change accordingly). For 0.5U and larger payload slots, it is possible to customize design the mechanical interface subject to discussion with the Waratah Seed team.

### 4.5.2. Customized mechanical interface for larger payloads

For 0.5U or larger payloads, it is possible to design a customized mounting structure. It is also possible, for larger payloads, to have apertures and to protrude outside the satellite structure for up to 6.5mm (subject to launcher’s requirements). However, the location of the apertures, protrusions and customized structure designs will be subject to other design constraints (i.e. ADCS design, solar panel design etc.). If customized design is desired, please discuss with the Waratah Seed team as early as possible and certainly before 30<sup>th</sup> Dec 2021. Such customized design may also involve extra costs.



## 5. WS-1 Design Restrictions and suggestions

- 1) No battery or supercapacitor is allowed on the payload. The payload MCU will sync the time with the OBC when start/restarted if time-stamped payload operation is required.
- 2) Use Surface Mounting Components (SMC) where possible for better vibration and vacuum performance.
- 3) All mechanical design shall specify 10µm (or lower) as tolerance to the manufacturers
- 4) Conformal coating is welcomed for flight models
- 5) Please use NASA’s outgassing data to guide your material selection: <https://outgassing.nasa.gov/>. CUAVA recommends the below glues and tapes based on our past missions:
  - Thermal Tape: Sigraflex Foil F05010E or F05010TH or Cho-therm 1671
  - Aluminium tape: 3M™ Aluminium Foil Tape 425 and 435 (425 has been tested in vacuum chamber).
  - 3M Scotch-Weld 2216 Epoxy
  - UHU 300 Epoxy
  - Thread locker: Loctite 243 (Not included in the NASA database but widely used)

## 6. Qualification Testing/Flight Acceptance and Licencing

All WS-1 payloads shall complete a vibration test for sinusoidal and random vibration unless waived by the Waratah Seed engineering team. A recommended qualification level is shown in Table 2. **The acceptance test level will be updated once the launch vehicle is selected.**

**Table 2 Recommended Acceptance test level (NASA GEVS Table 2.4-3).**

Frequency (Hz)	ASD Level (g <sup>2</sup> /Hz)
	<b>Acceptance</b>
<b>20</b>	0.013
<b>20 – 50</b>	+6dB/Oct
<b>50 – 800</b>	0.08
<b>800 – 2000</b>	-6dB/Oct
<b>2000</b>	0.013
<b>Overall</b>	10 G <sub>rms</sub>
<b>Duration (minutes/axis)</b>	2

Thermal vacuum test is recommended but not mandatory. The Waratah Seed team reserves the right to require a thermal bakeout if a payload sensitive to outgassing (i.e. an optical payload) is selected for WS-1.

All payloads that generate RF signals (for both communication and non-communication purposes) must coordinate with the Waratah Seed team after selection to obtain frequencies coordination provided by International Amateur Radio Union (IARU), and International Telecommunication Union (ITU).

## 7. Project schedule

We aim to deliver the WS-1 satellite by the end of August 2022, subject to the launch schedule. The Waratah Seed team needs to provide a 6-month notice (TBC) if we want to delay the launch. Also, the Waratah Seed team will need at least 4 months to assemble, integrate and test the WS-1 satellite prior to delivery. Hence, all payload teams must deliver the Engineering Model (EM) by 31<sup>st</sup> of March 2022 and Flight Model (FM) by 30<sup>th</sup> June 2022 to Waratah Seed. The Waratah Seed team reserve the rights to reject the payload without refund if the due days are not or cannot be met.

The current schedule with estimated due dates is listed below.

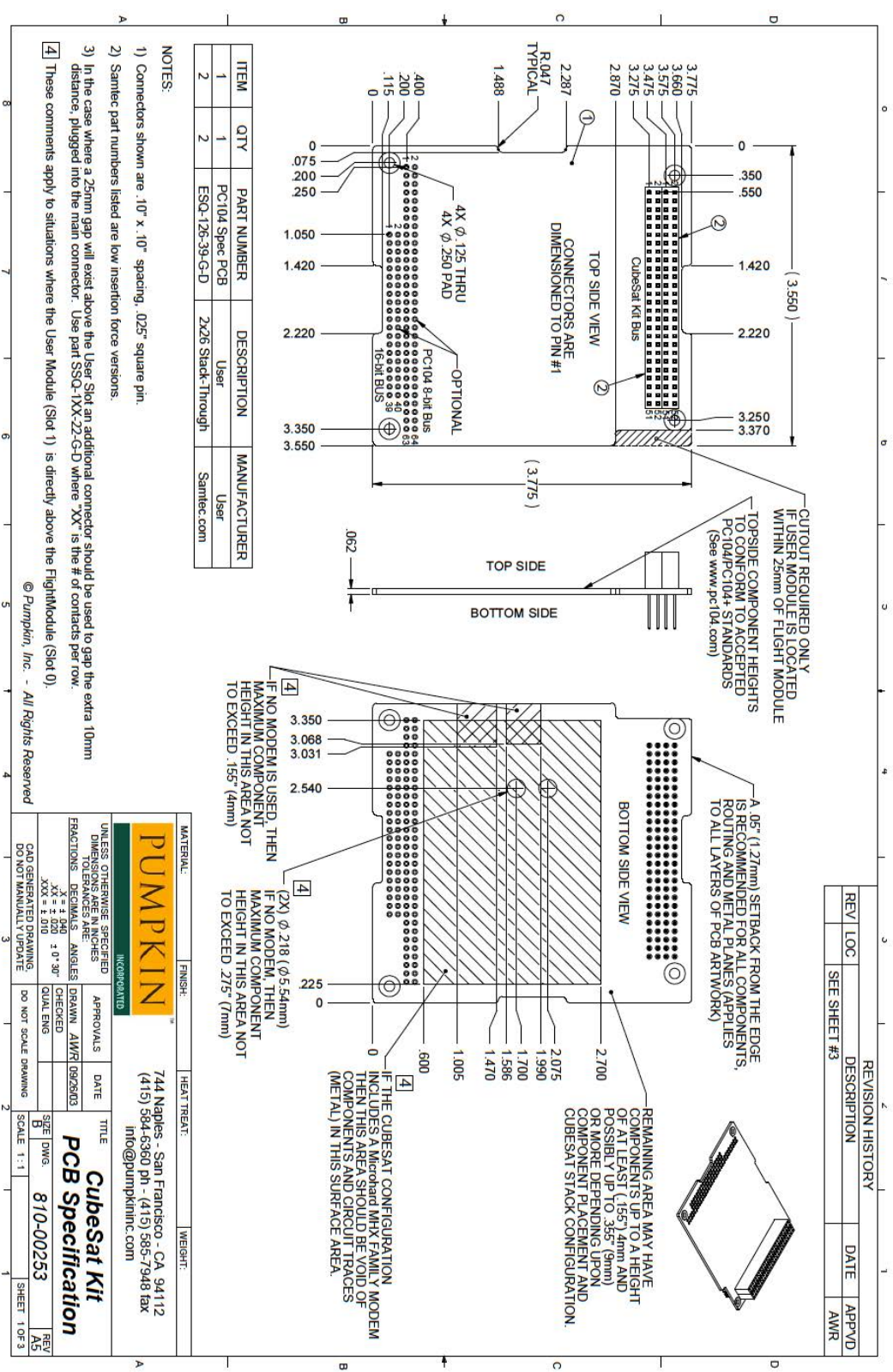

**Table 3 WS-1 Project Schedule**

Milestone	Estimated Due Date
Interface Control Document	31 <sup>st</sup> August 2021
Rideshare Payload Applications close	28 <sup>th</sup> Sep 2021
Shortlisted applicants notified	5 <sup>th</sup> October 2021
Private Pitch	19 <sup>th</sup> October 2021
Public Pitch	9 <sup>th</sup> November 2021
Written applications close	30 <sup>th</sup> November 2021
Finalists and shortlist announced	10 <sup>th</sup> December 2021
Preliminary Design Review	30 <sup>th</sup> January 2022
Payload EM delivery	31 <sup>st</sup> March 2022
Payload EM functional and vibration Testing	30 <sup>th</sup> April 2022
Critical Design Review	30 <sup>th</sup> April 2022
Payload FM delivery	30 <sup>th</sup> June 2022
FM Satellite integration and Functional testing	31 <sup>st</sup> July 2022
Environmental testing	1 <sup>st</sup> September 2022
FRR and delivery	1 <sup>st</sup> October 2022



Annex 1, Imperial (in) version of Cubesat Kit PCB specification (credit to Pumpkin Inc.)



## Technical Readiness Guidelines

### TRL 9

- Actual system “flight proven” through successful mission operations

### TRL 8

- Actual system completed and “flight qualified” through test and demonstration (ground or space)

### TRL 7

- System prototype demonstration in a space environment

### TRL 6

- System/subsystem model or prototype demonstration in a relevant environment (ground or space)

### TRL 5

- Component and/or breadboard validation in relevant environment

### TRL 4

- Component and/or breadboard validation in laboratory environment

### TRL 3

- Analytical and experimental critical function and/or characteristic proof-of-concept

### TRL 2

- Technology concept and/or application formulated

### TRL 1

- Basic principles observed and reported



**TIMELINE:**

Payload Competition Joint Press Release/Guidelines	- 24 Aug 2021
Payload Competition Launch/ Applications Open	- 31 Aug 2021
Commercial Clients Press Release/Guidelines	- 7 Sep 2021
Commercial Client Applications Open	- 7 Sep 2021
Payload Competition Decisions	- 7 Dec 2021
Commercial Client Selection Close	- 7 Dec 2021 or earlier, depending on demand.
Flight Model payload delivery deadline	- 30 June 2022, currently.

**CONTACT:**

Waratah Seed Space Qualification Mission Payload Competition (WS-1) Info Packs and Guidelines can be downloaded at [Waratah Seed Project](#) on the CUAVA website.

For more information or assistance, please contact the Waratah Seed Administration and Outreach Officer. Email: [info@waratahseed.space](mailto:info@waratahseed.space) | Phone: 02 9036 7960

W: [waratahseed.space](http://waratahseed.space)      LinkedIn: [waratah-seed-space](https://www.linkedin.com/company/waratah-seed-space)      Twitter ([@waratahseed](https://twitter.com/waratahseed))